

 **Easy Gates** *Direct*

CAST IRON COLLECTION

Posts, Railings, Driveway & Pedestrian Gates

APR 2016





Cast Iron Collection



Our range of 19th century inspired cast iron gates and railings offer a variety of high quality designs at great value. Crafted in solid cast iron and developed with modern requirements in mind, allowing the use of integrated automation and intercom systems.

Simply pick the sizes and design from the ranges available.

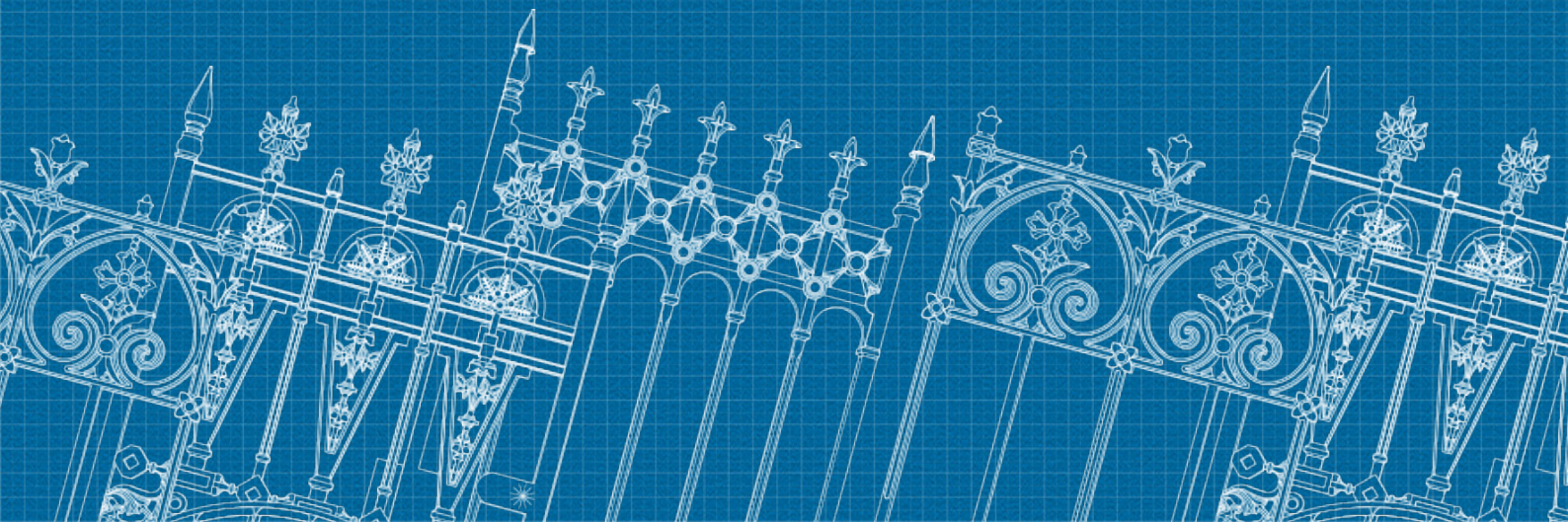

Stewart Collection

Gates and Railings



This authentic range of cast iron gates and railings have been inspired by 19th Century design, originating in Falkirk at the famous Sun Foundry, circa 1892

Railings	Driveway Gates	Pedestrian Gates
Stewart half height railing panel Height: 945mm Width: 430mm	Pair of 12 x 5.5ft Stewart driveway gates Height: 1610mm Width: 3560mm	Stewart pedestrian gate 3 x 5.5ft Height: 1610mm Width: 880mm
Stewart half height joining panel Height: 945mm Width: 282mm		
Stewart full height railing panel Height: 1550mm Width: 285mm	Pair of 10 x 5.5ft Stewart driveway gates Height: 1610mm Width: 2960mm	Stewart Gate Posts Pillar Gate Post Plate Page: 9 Pillar Gate Post Root Page: 9
Stewart full height joining panel Height: 1550mm Width: 285mm		

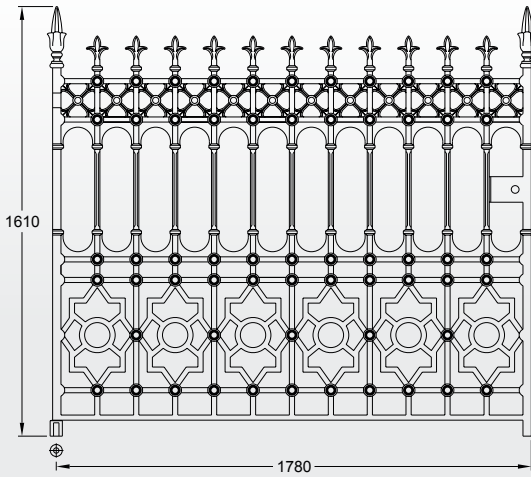

Stewart driveway gate leaf
(12ft pair, 450kg)

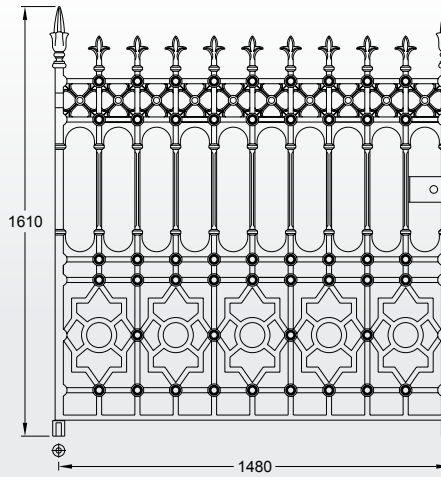

Stewart driveway gate leaf
(10ft pair, 370kg)

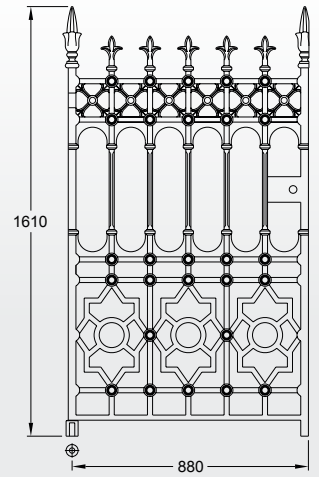

Stewart pedestrian gate
(3ft, 117kg)

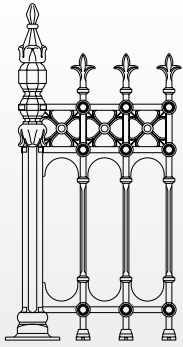

Stewart half height railing & Stewart half height intermediate railing post

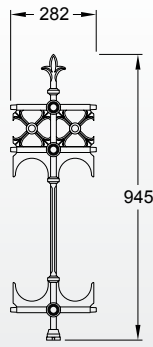

Stewart half height joining panel (10kg)

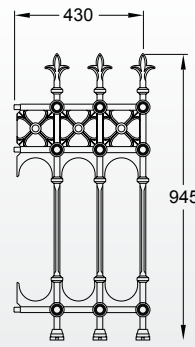

Stewart half height railing panel (20.5kg)

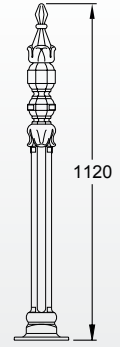

Stewart half height intermediate railing post (23kg)

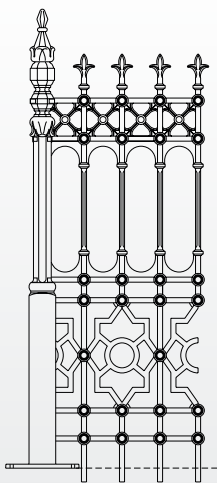

Stewart full height railing & Stewart full height intermediate railing post

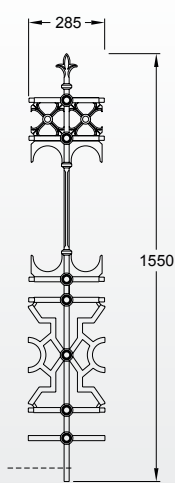

Stewart full height joining panel (18kg)

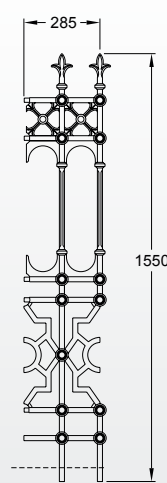

Stewart full height railing panel (24kg)

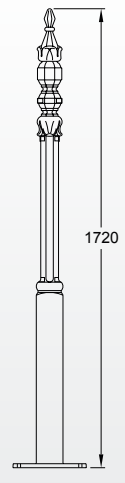

Stewart full height intermediate railing post (38.5kg)

Stirling Collection

Gates and Railings



The Stirling Collection is based on a traditional design. This features a tall gate which is ideal for private homes with large driveways. The collection includes cast iron driveway gates, pedestrian gates, gate post, railings and railing posts.

Railings	Pedestrian Gates	Driveway Gates
Stirling half height railing panel Height: 1430mm Width: 435mm	4 x 6ft Stirling pedestrian gate Height: 1800mm Width: 1180mm	Pair of 12 x 7ft Stirling driveway gates Height: 2100mm Width: 3560mm
Stirling half height joining panel Height: 1430mm Width: 285mm	3 x 6ft Stirling pedestrian gate Height: 1800mm Width: 890mm	Pair of 12 x 6ft Stirling driveway gates Height: 1800mm Width: 3560mm
Stirling full height railing panel Height: 2010mm Width: 184mm	4 x 7ft Stirling pedestrian gate Height: 2100mm Width: 1180mm	Pair of 14 x 6.5ft Stirling driveway gates Height: 1980mm Width: 4160mm
Stirling full height joining panel Height: 2010mm Width: 450mm	3 x 7ft Stirling pedestrian gate Height: 2100mm Width: 890mm	Stirling Gate Posts Pillar Gate Post Plate Page: 9 Pillar Gate Post Root Page: 9

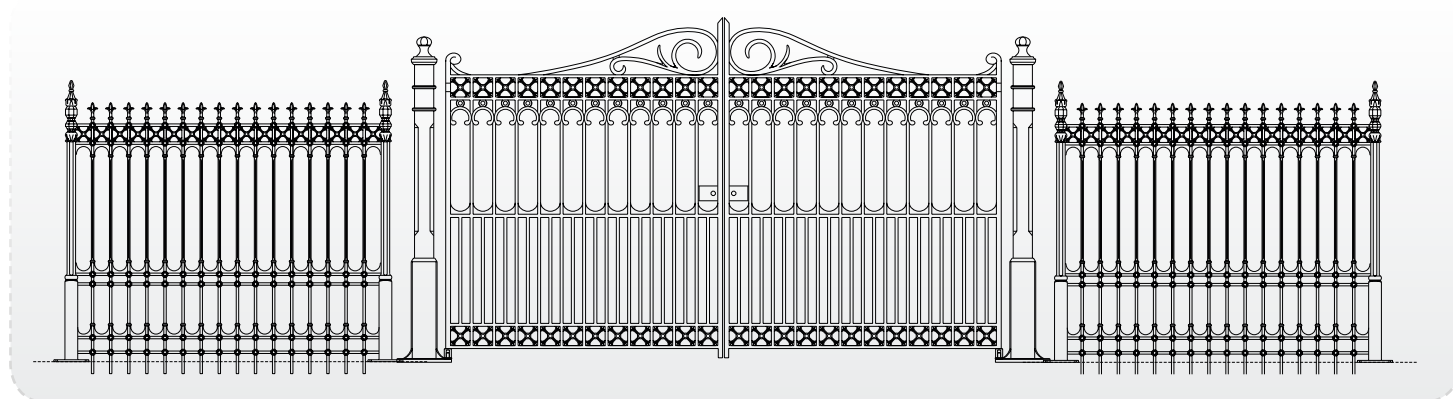

Stirling railing panels are versatile in design, and can be used in combination with the Stewart or Argyle gates. Already have gates installed? The Stirling collection can be installed alongside most standard cast iron designs.

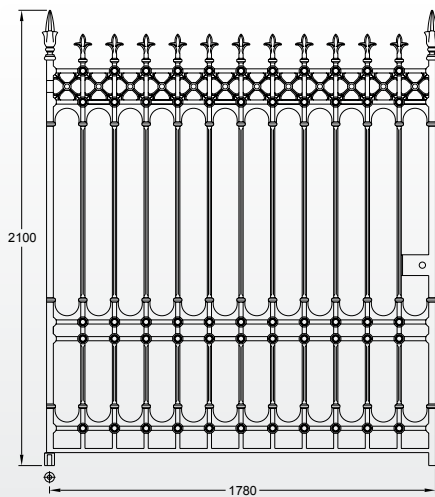

*Stirling driveway gate
(12 x 7ft pair, 510kg)*

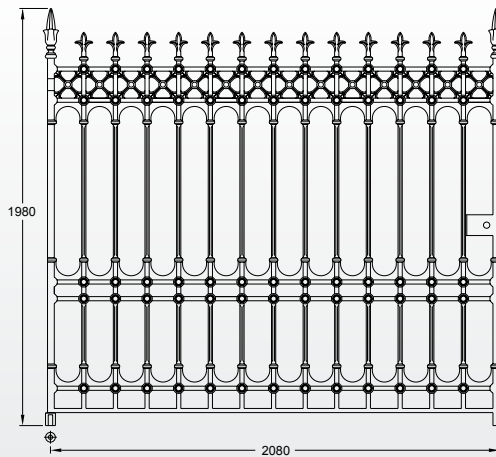

*Stirling driveway gate
(14 x 6.5ft pair, 620kg)*

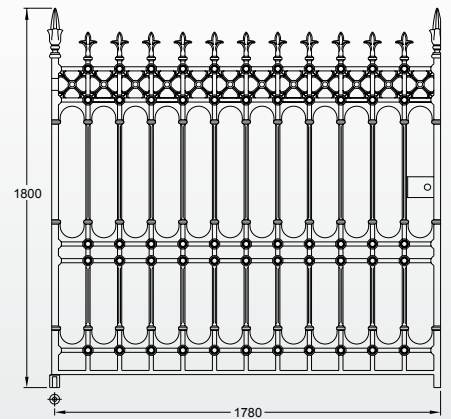

*Stirling driveway gate
(12 x 6ft pair, 400kg)*

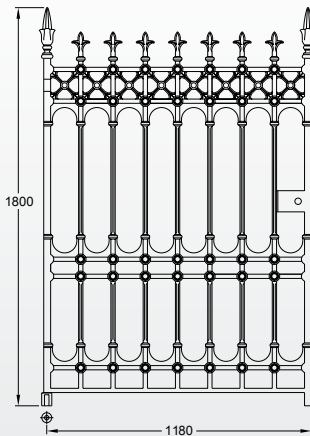

*Stirling pedestrian gate
(4 x 6ft, 178kg)*

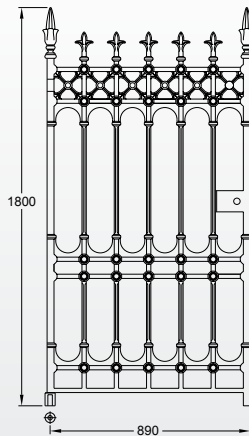

*Stirling pedestrian gate
(3 x 6ft, 178kg)*

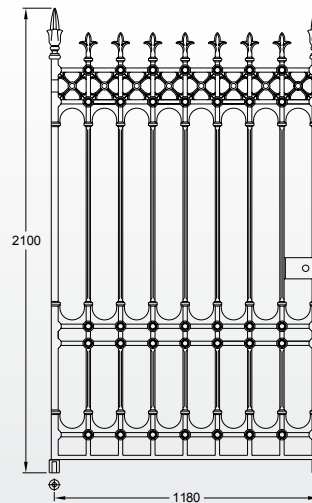

*Stirling pedestrian gate
(4 x 7ft, 178kg)*

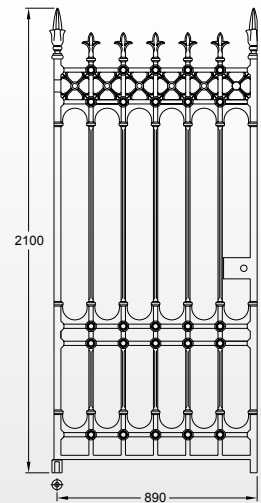

*Stirling pedestrian gate
(3 x 7ft, 142kg)*

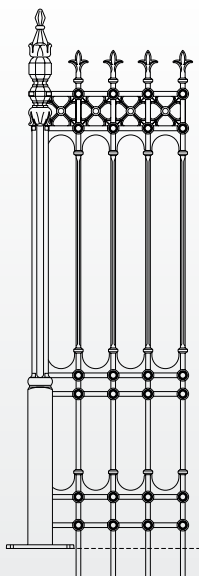

*Stirling full height railing & Stirling full
height intermediate railing post*

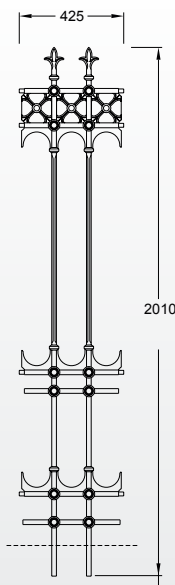

*Stirling full height joining
panel (18kg)*

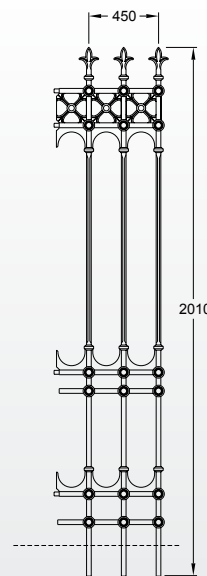

*Stirling full height railing
panel (24kg)*



*Stirling full height intermediate
railing post (38.5kg)*

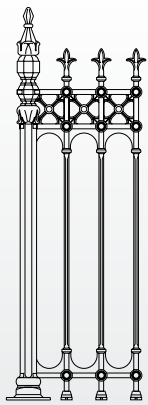

Stirling half height railing & Stirling half height intermediate railing post

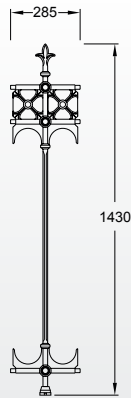

Stirling half height joining panel (27kg)

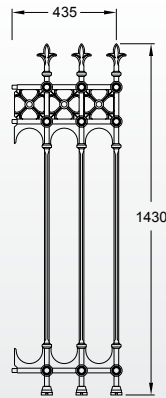

Stirling half height railing panel (33kg)

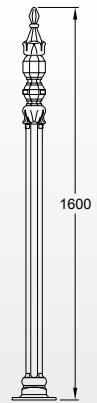

Stirling half height intermediate railing post (40kg)

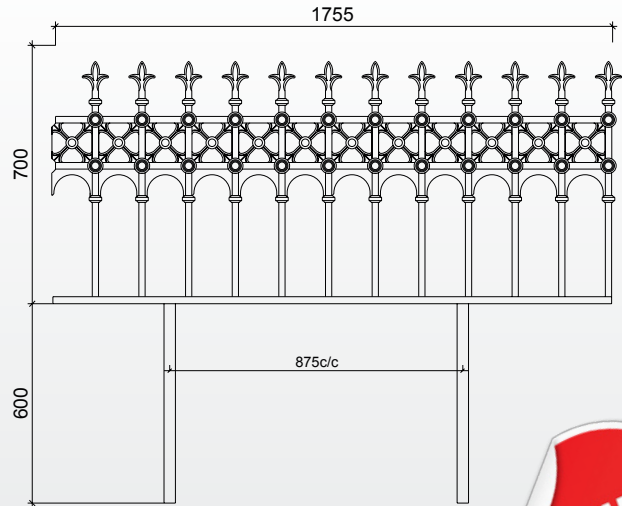
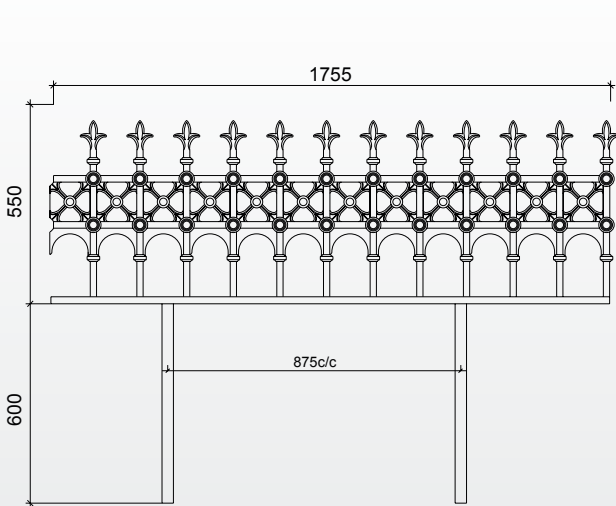

Stirling wall mounts are perfect for low walls, the mounting posts are inserted into evenly drilled holes making it a great solution to uneven or decorative stone walls.

Railings

Stirling wall mount
Height: 550mm
Width: 1800mm

Stirling wall mount
Height: 700mm
Width: 1800mm

Gilberton Collection

Gates and Railings

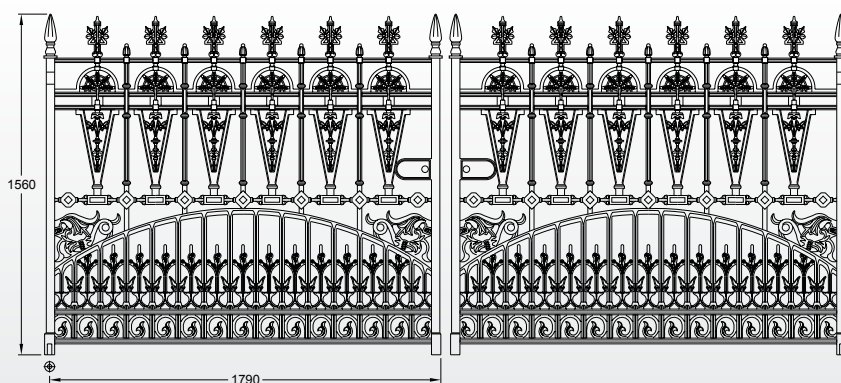

Gilberton driveway gate leaf (12ft pair, 464kg)

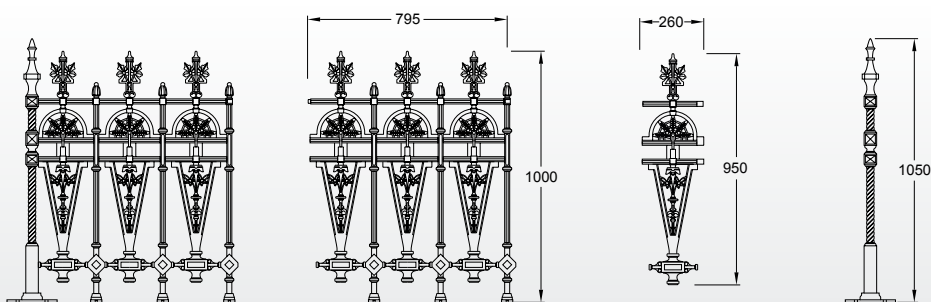

Gilberton railing panel & Gilberton intermediate railing post

Gilberton railing panel (40kg)

Gilberton joiner panel (11kg)

Gilberton intermediate railing post (15kg)

The popular Gilberton Collection is very decorative and features intricate detail.

Railings

Driveway Gates

Gilberton railing panel
Height: 1000mm
Width: 800mm

Gilberton joiner panel
Height: 950mm
width: 260mm

Gilberton railing post
Height: 1050mm
Width: 60mm
Base plate width: 200mm

Pair of 12ft Gilberton driveway gates
Height: 1560mm
Width: 3580mm

Pillar gate post
Height: 1830mm
Base plate width: 360mm
Post width: 170mm
Top width: 200mm

Argyle Collection

12ft Driveway Gates

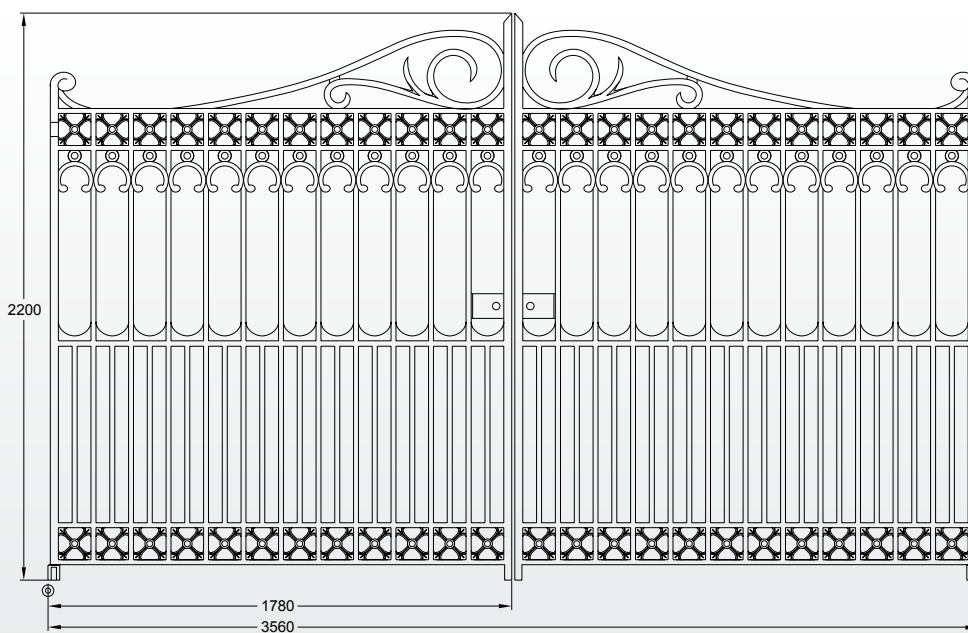

Argyle driveway gates

The Argyle is the latest addition to our Cast Iron range. The gate incorporates a decorative scroll to the top rail, which is a feature unique to this product.

Driveway Gates

Pair of Argyle driveway gates

Height: 2200mm

Width: 3560mm

Eglington Collection

Private Residence



The Eglington Collection has been developed with the private home in mind. The low railing panel is ideal for adding decorative detail to perimeter walls.

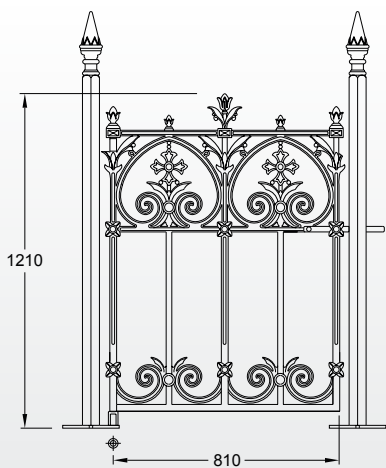

Terrace pedestrian gate (45kg) & Terrace pedestrian gate post (29kg)

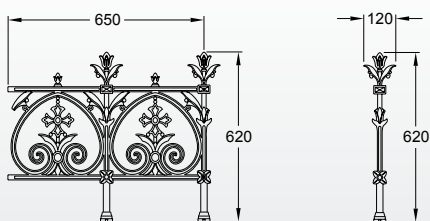

Terrace railing panel (36.5kg)

Terrace intermediate railing post (3kg)



Driveway Gates

Eglington pedestrian gate with gate posts

Gate Height: 1210mm
Gate Width: 810mm

Railings

Eglington railing panel with feet

Height: 620mm
Width: 650mm

Eglington Gate Posts

Pillar Gate Post Plate

.... Page: 9

Gate Posts

Root & Plate

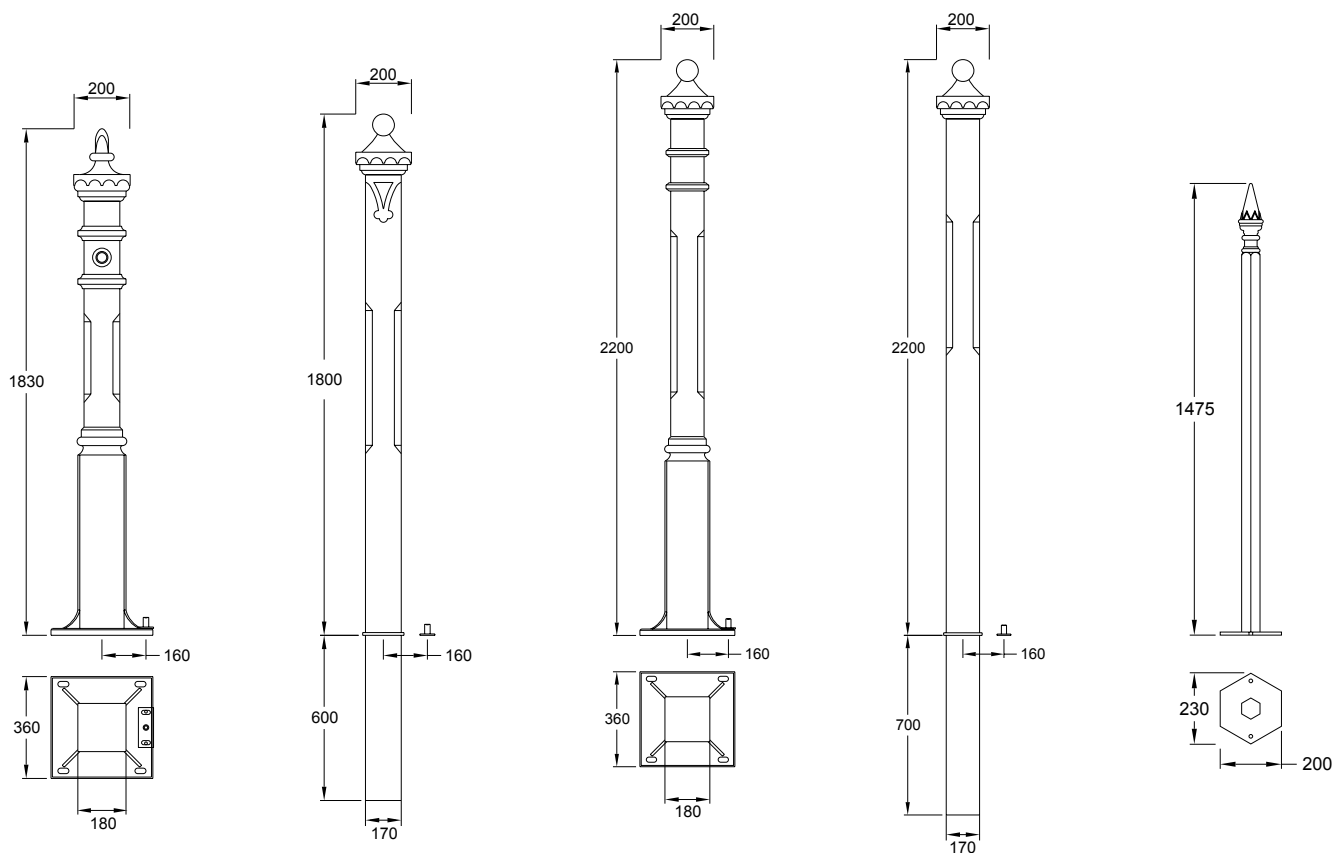

Stewart Gate Posts		Stirling Gate Posts		Eglington Gate Post
Pillar Gate Post Plate	Pillar Gate Post Root	Pillar Gate Post Plate	Pillar Gate Post Root	Pillar Gate Post Plate
Height: 1830mm Base Plate Width: 360mm Body Width: 180mm Top Width: 200mm	Height: 1800mm Body Width: 170mm Top Width: 200mm	Height: 2220mm Base Plate Width: 360mm Body Width: 180mm Top Width: 200mm	Height: 2220 mm Body Width: 170mm Top Width: 200mm	Height: 1475mm Width: 60mm Base Plate Width: 200mm

Example Installations

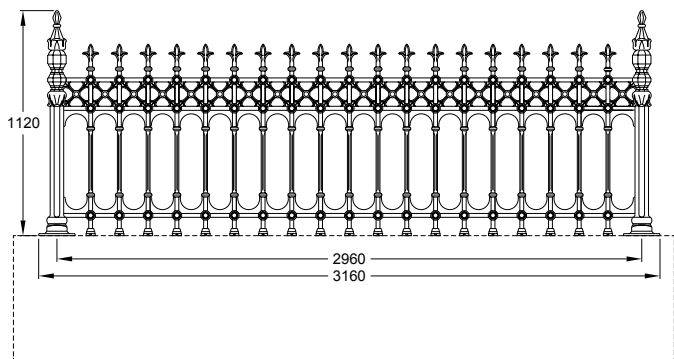

STEWART HALF HEIGHT RAILINGS

- 2x Stewart half height railing posts
- 6x Stewart half height railing panel with feet
- 1x Stewart half height railing joiner panel with feet
- Single half height railing stay suggested or as necessary to suit installation

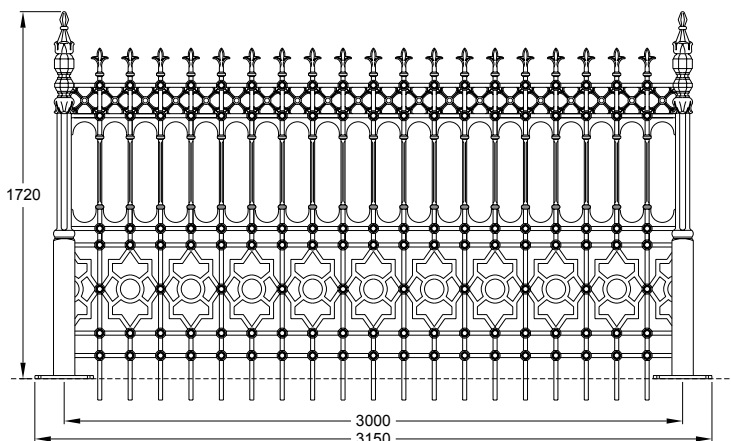

STEWART FULL HEIGHT RAILINGS

- 2x Stewart full height railing posts
- 9x Stewart full height railing panel with root fixing
- 1x Stewart full height railing joiner panel with root fixing
- Single full height railing stay suggested or as necessary to suit installation

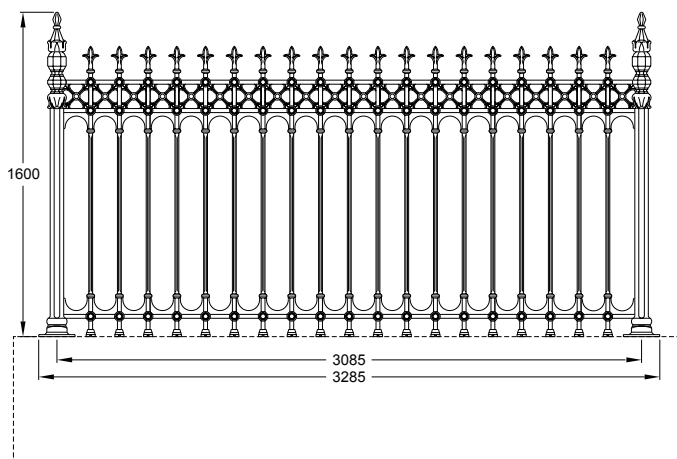

STIRLING HALF HEIGHT RAILINGS

- 2x Stirling half height railing posts
- 6x Stirling half height railing panel with feet
- 1x Stirling half height railing joiner panel with feet
- Single half height railing stay suggested or as necessary to suit installation

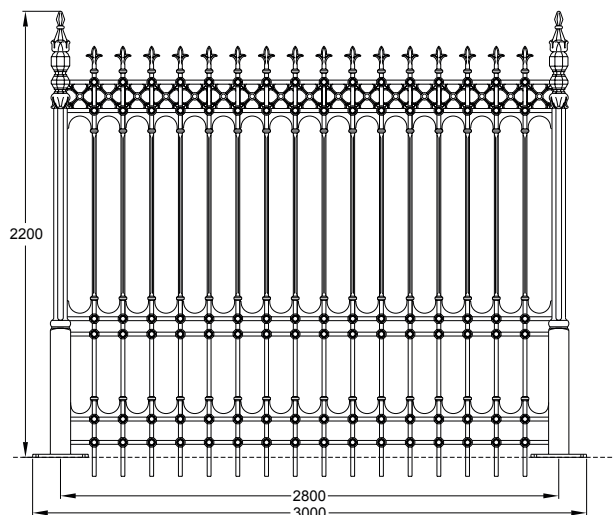

STIRLING FULL HEIGHT RAILINGS

- 2x Stirling full height railing posts
- 8x Stirling full height railing panel with root fixing
- 1x Stirling full height railing joiner panel with root fixing
- Single full height railing stay suggested or as necessary to suit installation

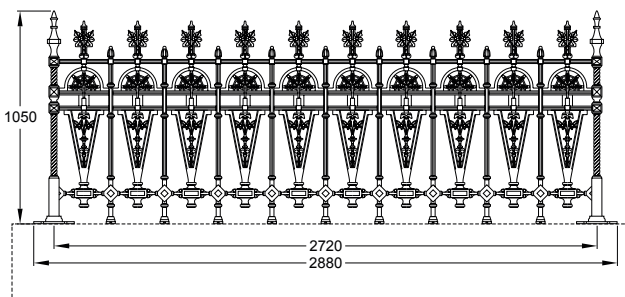

GILBERTON RAILINGS

- 2x Gilberton railing posts
- 3x Gilberton railing panel with feet
- 1x Gilberton railing joiner panel with feet
- Single half height railing stay suggested or as necessary to suit installation

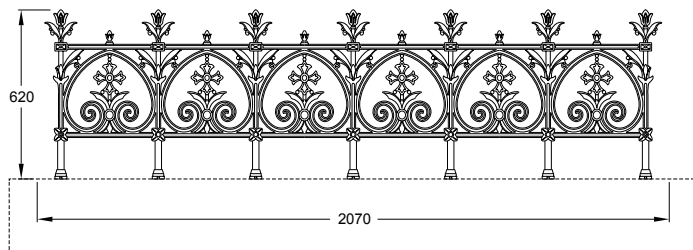

EGLINGTON RAILINGS

- 2x Prospect railing posts
- 3x Prospect railing panel with feet
- Single half height railing stay suggested or as necessary to suit installation



Find us online at

EasyGates *Direct* .co.uk



DISTRIBUTION partners of **GTE Force Testers**
and **ASO Safety Solutions** product range

Unit 16 James Scott Road,
Halesowen,
West Midlands,
B63 2QT



0845 054 50 70



easygatesdirect.co.uk



info@easygatesdirect.co.uk

